

# FP series

Fully illuminated pushbutton switches - bushing Ø 24 mm - momentary or latching

*Distinctive features and specifications*

UG1410-A-R2



- Threaded bushing
- Full actuator or symbol illumination
- Large but lightweight
- Sealed to IP69K
- Pad printed or laser etched symbols

	Pad printing	Laser
Non-illuminated		
Illuminated		

## ELECTRICAL SPECIFICATIONS

- Max. current/voltage rating with resistive load :
  - silver contacts (code 2) : 4A 12VDC
  - gold plated contacts (code 4) : 200mA 12VDC
- Initial contact resistance : 50 mΩ max.
- Insulation resistance : 1 GΩ min. at 500VDC
- Dielectric strength : 1.000 Vrms 50 Hz min.
- Electrical life at full load :
  - Momentary models : 1 million cycles (gold plated contacts)
  - 400.000 cycles (silver contacts)
  - Latching models : 200.000 cycles

## MATERIALS

- Case : PA46
- Actuator : PA12
- Bushing/ bezel : PA66
- Contacts : silver (code 2) or silver, gold plated (code 4)
- Cable : length 300 mm, section depending on switch model
- Terminal seal : epoxy or overmolding

## GENERAL SPECIFICATIONS

- Front panel sealing : IP69K according to DIN 40050-9
- Panel thickness : 1(.039) to 18 mm (.708) max.
- Total travel : 2,5 mm ± 0,5 mm
- Typical operating force : 8N ± 2N
- Low level or mechanical life :
  - Momentary models : 1 million cycles
  - Latching models : 200.000 cycles
- Torque : 3 Nm max. applied to nut
- Operating temperature : -40°C to +75°C

## WIRING DIAGRAM

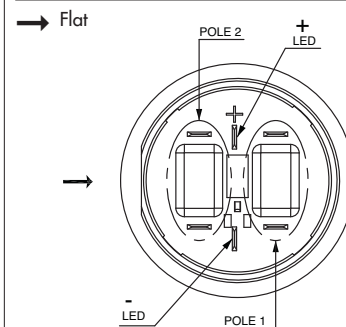

The company reserves the right to change specifications without notice.

# FP series

Fully illuminated pushbutton switches - bushing Ø 24 mm - momentary or latching

## Overview

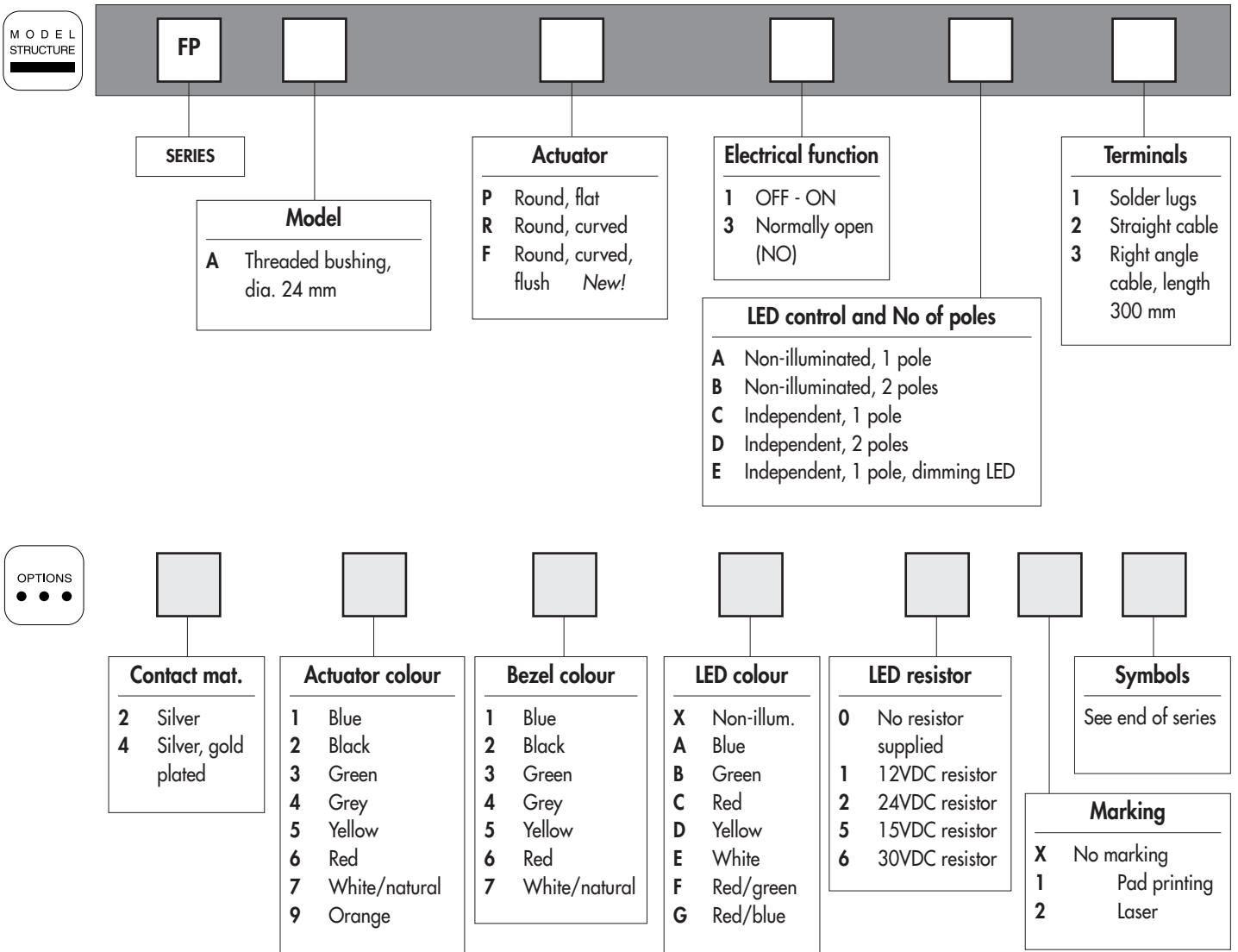

### ABOUT THIS SERIES

On the following pages, you will find successively :  
model structure of switches and options in the same order as in above chart

**Dimensions** : first dimensions are in mm while inches are shown as bracketed numbers.



**NOTICE** : please note that not all combinations of above numbers are available. Refer to the following pages for further information.



**Mounting accessories** : Standard hardware supplied : 1 hex nut and 1 O-Ring



**Packaging unit** : solder lug versions : 20 pieces - cable versions : 1 piece



# FP series

Fully illuminated pushbutton switches - bushing  $\varnothing$  24 mm - momentary or latching

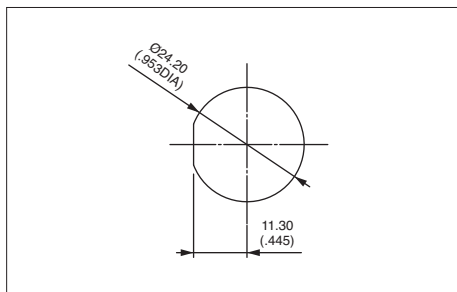

- Three terminal types
- Curved or flat actuator

To order a product, replace • with one of the codes selected under "LED control and number of poles" on next page, then add the desired options.

MODEL STRUCTURE



## Solder lug terminals



LATCHING  
Curved actuator  
**FPAR1•1**  
Flat actuator  
**FPAP1•1**

MOMENTARY (NO)  
Curved actuator  
**FPAR3•1**  
Flat actuator  
**FPAP3•1**

OFF - ON

OFF ON



→ Flat

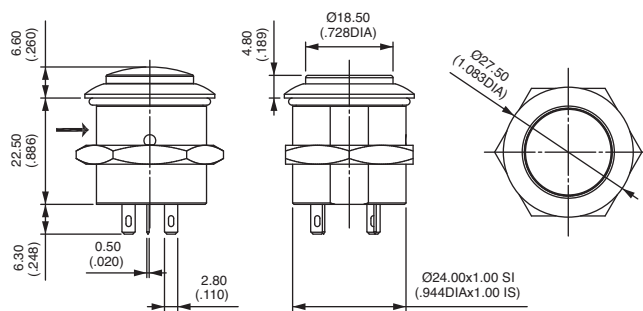

## Straight cable terminals



LATCHING  
Curved actuator  
**FPAR1•2**  
Flat actuator  
**FPAP1•2**

MOMENTARY (NO)  
Curved actuator  
**FPAR3•2**  
Flat actuator  
**FPAP3•2**

OFF - ON

OFF ON



→ Flat

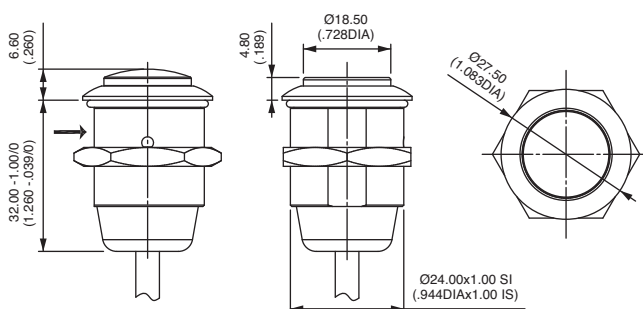

## Right angle cable terminals



LATCHING  
Curved actuator  
**FPAR1•3**  
Flat actuator  
**FPAP1•3**

MOMENTARY (NO)  
Curved actuator  
**FPAR3•3**  
Flat actuator  
**FPAP3•3**

OFF - ON

OFF ON



→ Flat

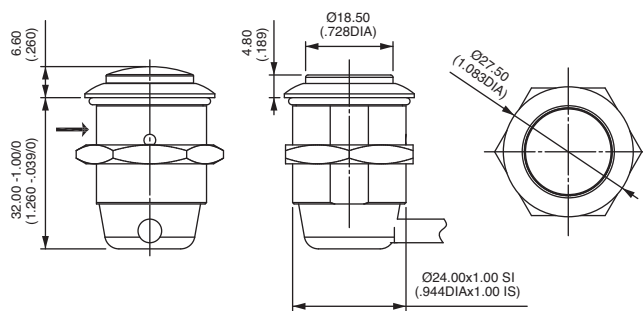

# FP series

Fully illuminated pushbutton switches - bushing Ø 24 mm - momentary or latching

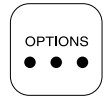

## Options

B2

### LED CONTROL AND NUMBER OF POLES

Complete the model numbers on previous pages with one of the following codes.

	Function 1 (latching)	Function 3 (momentary)		Function 1 (latching)	Function 3 (momentary)
Non-illuminated one pole <b>A</b>			Independent one pole <b>C</b>		
Non-illuminated two poles <b>B</b>			Independent two poles <b>D</b>		
			Independent one pole Dimming LED <b>E</b>		dotted line = jumper to be wired by the user. LED- has to be wired to one pin of pole 2.

### CONTACT MATERIALS

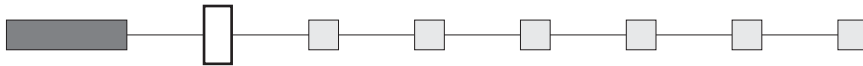

- 2 Silver
- 4 Silver, gold plated

### ACTUATOR COLOUR

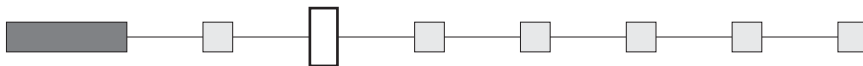

- 1 : blue - 2 : black - 3 : green - 4 : grey - 5 : yellow - 6 : red - 7 : white/natural - 9 : orange

### BEZEL COLOUR

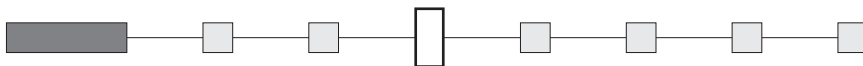

- 1 : blue - 2 : black - 3 : green - 4 : grey - 5 : yellow - 6 : red - 7 : white/natural

### LED COLOUR

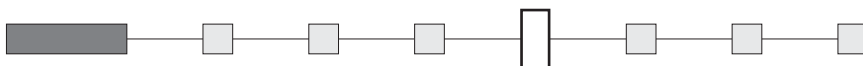

- X : non-illuminated
- A : blue - B : green - C : red - D : yellow - E : white - F : red/green - G : red/blue



# FP series

Fully illuminated pushbutton switches - bushing Ø 24 mm - momentary or latching

Options

## LED RESISTOR

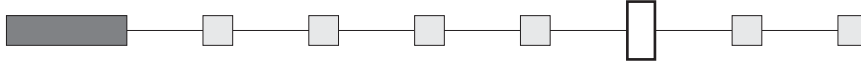

- 0 No resistor supplied
- 1 12VDC resistor
- 2 24VDC resistor
- 5 15VDC resistor
- 6 30VDC resistor

## MARKING

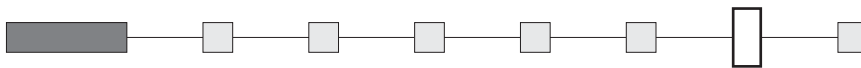

- X No marking
- 1 Pad printing
- 2 Laser

## SYMBOLS

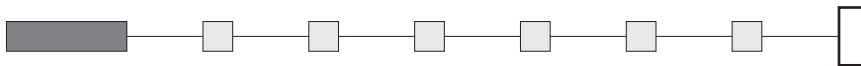

Blank No symbol

**Available symbols**  
See end of K-range, section D.

**Marking colour**  
White marking for illuminated actuators (laser etching) and non-illuminated black actuators (pad printing). Black marking for non-illuminated colour actuators (pad printing). Other : on request.

**Marking area**  
The symbol will be included in the hatched area.

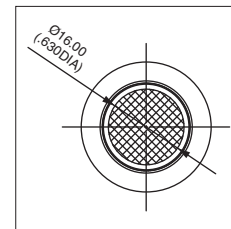

→ Flat

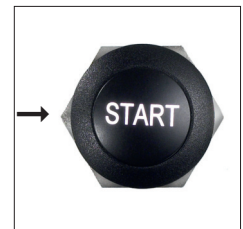

# FP series

Fully illuminated pushbutton switches - bushing Ø 24 mm - momentary or latching

## Symbols

Most symbols meet the ISO 7000 standard "graphical symbols for use on equipments" (code given in bracket in the description). Contact us for symbols not featured in the following tables.

### Legend scale :

Depending on space available on the product (see "Symbols" section).

CODE	SYMBOL	DESCRIPTION
XX	None	-
01	ON	-
02	OFF	-
03	○	-
04	I	-
05	II	-
06	STOP	-
07	A	Stop
08	M	Motion
09	▲	Up motion
10	▼	Down motion
11	☀	Hot
12	❄	Cold
13	⚠	Hazard warning (0085)
14	☰	Traveller lighting
15	☷	Driver lighting (1421)

CODE	SYMBOL	DESCRIPTION
16	☂	Revolving light
17	☰	Rear ventilator
18	☶	Heating (0637)
19	🚪	Door opening
20	🚿	Windshield demister/defroster (0635)
21	🚿	Windshield wiper (0086)
22	🚿	Windshield washer (0088)
23	🌀	Ventilator fan (0089)
24	🚿	Side mirror defroster
25	🔄	Restarting pump
26	🚿	Front fog lights (0633)
27	🚿	Rear fog lights (0634)
28	🚿	Propulsion system trim
29	🚿	Beacon (1141)
30	⚓	Anchor
31	🔌	Electric motor (0011)

CODE	SYMBOL	DESCRIPTION
32	🚑	Emergency first aid vehicle (2565)
33	🚚	Load tipping (1557)
34	🚚	Loading light (2457)
35	🚚	Tractor, rear-ward (1667)
36	🚚	Combine, direction of movement (1678)
37	🚧	Use no forks (2406)
38	⚙	Transmission (1166)
39	🚰	Working spot light (1145)
40	🚗	Engine (0640)
41	📢	Horn (0244)
42	🔒	Lock (1656)
43	🚕	Taxi sign light (2551)
44	🚰	Working light (1204)
45	🚰	Working light symmetric (1204)
46	🔌	-
47	ASM	-

# FP series









































Fully illuminated pushbutton switches - bushing Ø 24 mm - momentary or latching

Symbols

Most symbols meet the ISO 7000 standard "graphical symbols for use on equipments" (code given in bracket in the description). Contact us for symbols not featured in the following tables.

### Legend scale :

Depending on space available on the product (see "Symbols" section).

CODE	SYMBOL	DESCRIPTION	CODE	SYMBOL	DESCRIPTION	CODE	SYMBOL	DESCRIPTION
48		All wheel drive	64		Indicator	80		Front windshield heating
49		Differential lock (1662)	65		Brake release	81	AUS	Aus
50		-	66		Baggage room left door	82		Radiator fan
51		-	67		Baggage room right door	83		Remove retarder
52		-	68		Power blinds	84		Restricted speed
53	N	-	69		Engine idle control	85		Preheater
54		Rear window wiper (0097)	70	CRUISE RES/SET	Cruise res/set	86		ABS detection
55		Rear window washer (0099)	71		Driver windows up/down	87		ECAS detection
56		Lower load (2223)	72		Middle door opening	88		Engine stop
57		Cab lock (1560)	73		Front door opening	89	CRUISE RES/CAN	Cruise res/cancel
58		Extraction	74		Lighting in baggage room	90		ECAS reset
59		Pumping in	75	CRUISE ON/OFF	Cruise on/off	91		Driver windows heating
60		Rear PTO (1572)	76	TV	TV	92	CRUISE SET+/SET-	Cruise set
61		Front PTO	77		Pump	93		Air bag up/down
62		Rockshaft down	78	WC	Toilet	94		Read lighting
63		Rockshaft up	79		Toilet decontamination	95		Lighting main switch

# FP series

















Fully illuminated pushbutton switches - bushing Ø 24 mm - momentary or latching

















Symbols





Most symbols meet the ISO 7000 standard "graphical symbols for use on equipments" (code given in bracket in the description). Contact us for symbols not featured in the following tables.

### Legend scale :

Depending on space available on the product (see "Symbols" section).

CODE	SYMBOL	DESCRIPTION
96		Heating using water
97		Low beam
98		Position lights
99		Diesel acceleration
A1		Manual mode
A2		Clockwise cabin rotation
A3		Anticlockwise cabin rotation
A4		-
A5		-
A6		Parking brake
A7		-
A8		-
A9		-
AA		-
AB		-
AC		-

CODE	SYMBOL	DESCRIPTION
AD		-
AE		-
AF		-
AG		Battery charging condition (0247)
AH		Turn signals (0084)
AJ		High beam (0082)
AK		Differential lock, bogie (2600)
AL		Brushing with a rotating brush (0070)
AM		Differential lock, transfer case 4x4 (2475)
AN		Loader bucket, float (1441)
AP		Loader bucket (1437)
AQ		Rear window washer & wiper (0098)
AR		Header Header drive (1579)
AS		Excavator/backhoe boom side shift (2091)
AT		Chemical water treatment (1851)
AU		Grapple skidder, single funct° boom (1762)

CODE	SYMBOL	DESCRIPTION
AV		-
AW		-
AY		-
AZ		-
B1	HIGH	-
B2	LOW	-
B3		-